



**K08A/K08AL**

**Ultrasonic Scaler**

---

**OPERATION MANUAL**

# CONTENT

Components.....	2
Copyright and Statement.....	3
Overview.....	4
Warning.....	4
Installation and connection.....	5
Preparing for Treatment.....	6
Manual for Wrench.....	7
Setting the ultrasound Power.....	8
Setting the Liquid Flow Rate.....	8
Foot Switch Functions.....	9
End of Treatment.....	9
Cleaning and Sterilizing.....	10
Maintenance.....	11
Safety Precautions.....	11
Storing the Product.....	13
Disposal.....	13
Warranty.....	13
Accessories.....	13
Contraindication.....	13
VRN Service.....	14
Symbols.....	15
Technical Date.....	16
Troubleshooting.....	17
EMC Declaration.....	21

## COMPONENTS

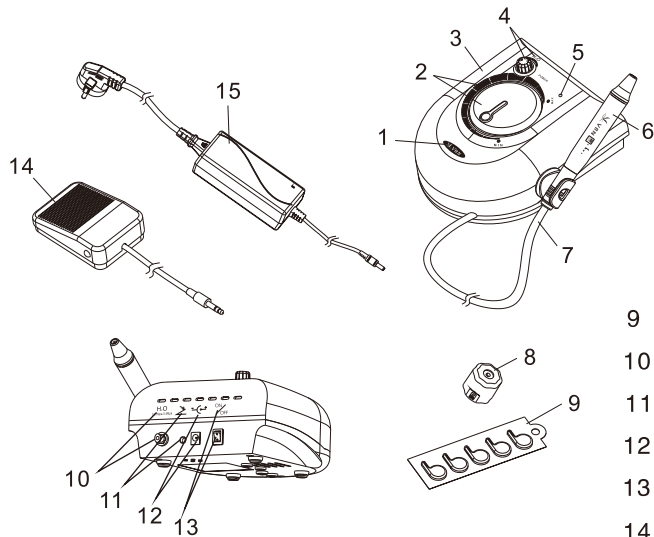

- 1 Model and LOGO
- 2 Vibration intensity knob and icon
- 3 Unit
- 4 Water volume knob and icon
- 5 Power LEDs
- 6 Detachable handpiece (K08A)  
Lighten handpiece (K08AL)
- 7 Detachable cable
- 8 Tip wrench
- 9 Tips
- 10 Fluid circuit connection and icon
- 11 Foot switch connection and icon
- 12 External power supply connection and icon
- 13 Power switch and icon
- 14 Foot switch
- 15 External power supply

## Copyright and statement

Copyright © URIT Medical Electronic Co. Ltd.

Congratulations to become valued customers of URIT Medical Electronic Co. Ltd. Thanks for using K08A/K08AL Ultrasonic scaler. It will bring you the new experiences and conveniences.

This instruction manual is including the latest information when printing. URIT Medical Electronic Co. Ltd. Reserves the rights to change the design of the equipment, the technique. Fittings the instruction manual and the content of original packing list at any time without notice. If there are some differences between blueprint and real product, take the real product as the norm.

This instruction manual is protected by copyright Law. Without any official authorization, any form of duplication, copy or translated into another language is not allowed.

Read the instruction manual originally delivered with each of the components before using this product and follow the instruction manual to operate. Otherwise, URIT Medical Electronic Co. Ltd. Dose not take any responsibility for any errors and damage o the product because of violation operation.



Note:

URIT Medical Electronic Co.,Ltd does not promise any implied guarantee to the product special use for merchantability and applicability.

If you need after-sale service support, please contact with authorization dealer or manufacturer.

## Overview

### 1. Structure and composition

K08A/K08AL ultrasonic scaler is mainly composed of function control circuit, liquid circuit, handle, tip and foot switch (wired).

### 2. Intended use

- a) Removing supra and sub gingival calculus deposits and stains from the teeth.
- b) Periodontal pocket lavage with simultaneous ultrasonic tip movement.
- c) Preparing, cleaning and irrigating root canals.

## Warning

The device is not suitable for use in the presence of flammable anesthetic mixtures with air or with oxygen or nitrous oxide.

The device requires no calibration.

The device is not repairable and contains no user serviceable parts.

No modification of this equipment is allowed. (3rd Edition)

The user must check that the equipment functions safely and see that it is in proper working condition before being used.

The manufacturer does not require such preventive inspections by other persons.

## INSTALLATION AND CONNECTION

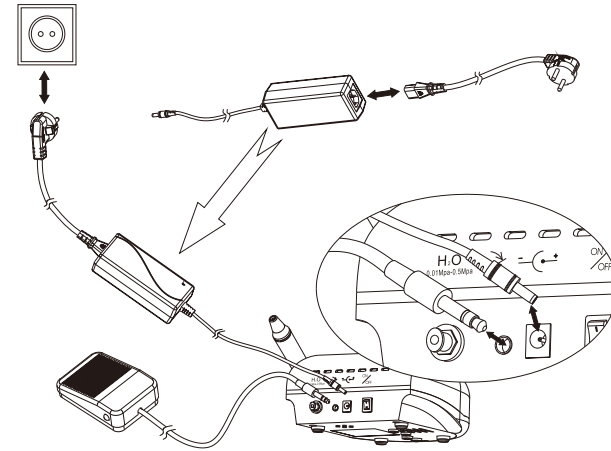

Always check that the unit is installed in a safe and stable position. An eventual fall may suddenly pull on the cord and the handpiece, hurting the patient and the user, and damaging the unit.

Check that the rated voltage of the power supply corresponds to the local line voltage to prevent damaging the unit.

Use the unit only in a FI protected mains supply (FI=Residual current protection).

For USA or Canada: connect only to an Hospital Grade outlet.

## PREPARING FOR TREATMENT

Normal Detachable Handpiece(K08A)

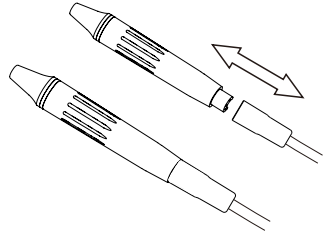

LED Detachable Handpiece(K08AL)

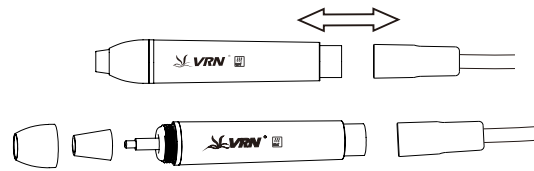

Clean and sterilize the different pieces and accessories of this product before each use. Please refer to the information provided in the operating instructions. Non-sterile pieces and accessories may cause bacterial or viral infections.

Blow dry the connections to remove eventual presence of liquid to ensure a proper electrical contact. Never blow compressed air in the irrigation connections as this will irretrievably damage internal parts.

## MANUAL FOR WRENCH

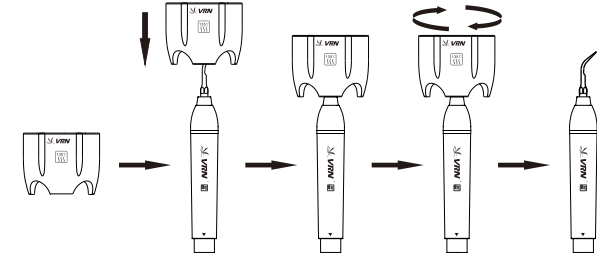

With a special structure design, wrench makes sure that users can handling the tip effectively during Using it, and protects user' s hand from hurting in the process of loading and unloading the tip.

Sterilization environment: Temperature:133℃(± 2℃), Pressure:193kPa~201kPa, in the steam Steps:

- (1)Align the legs of the wrench to the tip.
- (2)Install he tip: grip the handle, rotate the tip in right-hand wise till the tip does not turn around anymore.
- (3)Unloading the tip: grip handle then rotate the tip in counter-clockwise by wrench to remove it.
- (4)Once after using, please put the wrench into disinfection cabinet to sterilization.
- (5)After sterilization, the surface temperature of the wrench is too high to be used again, so users must wait until it is cool down, avoiding hurt.
- (6)When not use the wrench, put it at some place that is dry and ventilated, and keep it clean.

## SETTING THE ULTRASOUND POWER

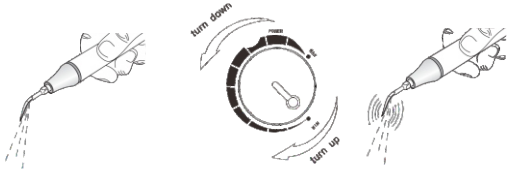

Adjust vibration intensity on-demand, generally, the medium is right, it also can be adjusted in the clinical course according to the sensitivity of patients and the hardness of the dental stone.



Adjust power to the lowest when just turn on the host.

## SETTING THE LIQUID FLOW RATE

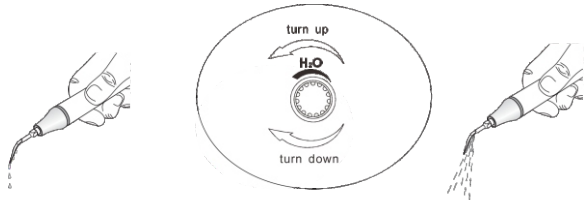

Depress the foot switch, and the tip starts vibrating, and then revolve the water volume knob and the water spraying puffs, it will cool down the handle and clean the surface of teeth.

Never work dry to avoid heat damage on the tooth. The tip of the instrument immediately heats up when used dry.



Adjust water volume to larger when just turn on the host.

## FOOT SWITCH FUNCTIONS



## END OF TREATMENT

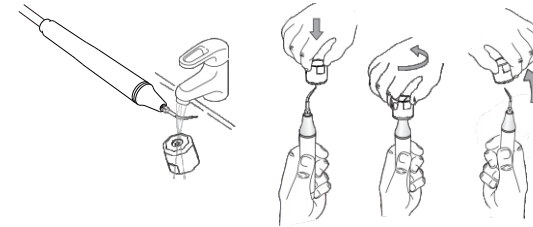



Clean the instrument with running water before sterilization.

Please conform to the recommendations of the "Reprocessing Instructions" manual delivered with your product regarding the procedures of cleaning and sterilization of the components.

## CLEANING AND STERILIZING

The details can refer to Cleaning and Sterilizing instructions.

Please read the instructions before cleaning and sterilizing and operate according the instruction.

## MAINTENANCE



A damaged or worn out O-ring must be replaced immediately.

Always use VRN original parts. Using non-original instruments may damage the unit, and practitioner or patient may be injured.

## SAFETY PRECAUTIONS

VRN and the dealer of this product accept no liability for direct or consequential injury or damage resulting from improper use, arising in particular through non-observance of the operating instructions, or improper preparation and maintenance.



Contraindication: ultrasonic oscillations may prevent cardiac pacemakers and defibrillators from functioning properly. Therefore, we recommend that patients with a cardiac pace maker or a defibrillator should not be treated with this product.

Use for the intended purpose only: before using the product, make sure that you have studied the operating instructions. This also applies to any equipment used with this product. Failure to observe the operating instructions may result in the patient or user suffering serious injury or the product.

Risk of explosion: do not use this product in the presence of flammable anaesthetics or gases. This product must be used only by trained and qualified personnel.

Clean and sterilize the different pieces and accessories of this product before each use.

Please refer to the information provided in the operating instructions. Non-sterile pieces and accessories may cause bacterial or viral infections.

This product has been investigated with regard to safety from electrical shock and fire hazard.

ETL(Electrical Testing Laboratories)has not investigated the physiological effects.

Always examine the product for damage before commencing treatment. Damaged accessories or a damaged unit must not be used and must be replaced. Use original VRN spare parts and accessories only.



Have this product exclusively repaired by an approved VRN repair center.

Use exclusively the external power supply delivered with the VRN unit.

Certain types of mobile telecommunication equipment could potentially interfere with this product. The separation distances recommended in the “Electromagnetic compatibility” manual must be taken into account.

## STORING THE PRODUCT

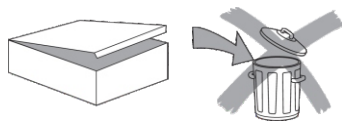

Keep the original packaging until the product is to be disposed of permanently. It can be used for shipping or storing at any time.

Should you wish to put your product out of use for an extended period of time:

- Proceed as described in the “cleaning and Sterilization” chapter.
- Pack the product and all accessories in the original packaging.

Please refer to the storage and transport conditions in the “Technical data” chapter.

## DISPOSAL

The product must not be discarded in domestic household waste.

Should you wish to definitively dispose of the product, please comply with the regulations which apply in your country.

Waste Electrical and Electronic Equipment belonging to customers located in the European Union may be shipped to VRN for recycling in accordance to the WEEE regulations. The costs of recycling, exclusive of shipping fees, are covered by VRN.

## WARRANTY

Damages due to non-adherence to the operating instructions or wear out of parts are excluded from warranty.



The warranty of your product will be cancelled if you try to open it.

## ACCESSORIES

Accessories are available from VRN or any authorized dealers. Please contact your customer service directly.

## Contraindication

Approval of a suitably qualified medical practitioner should be sought prior to use with haemophiliacs, or pregnant women, or children.

Ultrasonic oscillations may prevent cardiac pacemakers and deabulators. From functioning properly.

Therefore, we recommend that patients with a cardiac pace maker or a deabulator should not be treated with

this product.

Scaling generates an aerosol; patients with high-risk infectious diseases should not be treated as it may put others at risk.

### VRN SERVICE

Should your product need additional servicing or repairs, please send it to your dealer or to an authorized VRN Repair Center.

In the case of non-authorized repairs or damages due to non-adherence to the operating instructions, VRN accepts no liability whatsoever. This will also void the warranty.

It is best to ship your product in the original packaging. It protects your product against damage during shipment.























Risk of transmitting microorganisms!

To protect the personnel of the repair center and for safety reasons during transport and shipment, the product and the accessories returned to the factory for repair or revision must be cleaned and sterilized in accordance with the operating manual.

Repair can be refused for When sending your product directly to the approved VRN repair center, please include the name of your dealer. This simplifies processing.

### SYMBOLS

	Manufacturer's logo		Caution! Read the operation instruction		Class II equipment		Applied part, type B
	Disposal		Manufacturer		Used indoor only		Serial number
	Autoclavable		Storage Humidity		Storage Temp		Keep dry
	Fragile		Refer to instruction manual/booklet		Water supply 0.01Mpa-0.5Mpa		Power Switch
	Electrical outlet		Foot switch connection		Up		Period of use
	Production date	<b>IPX1</b>	Prevent water droplets intrusion				

## TECHNICAL DATA

Description  
Models  
Classification EN 60601-1

URIT Medical Electronic Co.,Ltd.  
K08A/K08AL  
-Class II  
-Applied part, Type B  
-IPX 0, unit  
-IPX 1, foot pedal  
Not category AP/APG equipment

Classification 93/42 EEC  
Operating mode

Class II  
Continuous operation

Power Supply

Adaptor Input

100-240 VAC / 50-60Hz

Adaptor Output

30VDC

Power consumption

30VA~48VA

External power supply

45W 30V 2m R5.5- 2.5+

Water Pressure

0.01MPa~0.5MPa

Ultrasonic specifications

Maximum output

8 Watts

Frequency range

25-31KHz

Net Weight

1.45kg

Dimensions in mm(HxWxD)

270mm x 23mm x 140mm

Operating conditions

10 °Cto 40°C

30% to 75% relative humidity

-20°C to 55°C

0% to 90% relative humidity

70kPa to 106kPa air pressure

Storage and transport conditions

## TROUBLESHOOTING

Fault	Possible cause	Solutions
The scaling tip doesn't vibrate and there is no water flowing out when stepping on the foot switch	The power plug is in loose contact	Make the plug insert to the socket well
	The foot pedal is in loose contact (wire foot switch)	Insert the foot switch to its socket tightly
	The fuse in the main unit is broken	Contact the dealers or us
	The battery for wireless control foot switch died	Change the new batteries
The scaling tip doesn't vibrate but there is no water flowing out when stepping on the foot switch	The tip is in loose contact	Screw the tip on the handpiece tightly
	The connect plug between the handpiece and the circuit board is in loose contact	Contact the dealer or us
	Handpiece problem	Send the handpiece to dealer or us to repair
	Cable problem	Contact the dealer or us
The scaling tip vibrates but there is no spray when stepping on the foot switch	The water control knob is not on	Turn on the water control knob [bote 1]
	There is impurity in the electric-magnetic valve	Take the electric-magnetic valve apart or contact the dealer or us
	The water system is blocked	Clean the water pipe by multi-function syringe [not 2]
There is still water flowing out after the power is off	The electric-magnetic valve problem	Contact the dealer or us
The handpiece generates heat	The water control knob is in a low setting	Turn the water control knob to a higher grade [note 1]

Fault	Possible cause	Solutions
The amount of spouting water is too little	The water control knob is in a low setting	Turn the water control knob to a higher grade [note 1]
	The water pressure is not high enough	Make the water pressure higher
	The water system is blocked	Clean the water pipe by multi-function syringe [note 2]
The vibration of the tip becomes weak	The tip has not been screwed on to the handpiece tightly	Screw the tip tightly
	The coupling between the handpiece and the cable is not dry	Dry it by the hot air
	The tip is damaged [note3]	Change the new scaling tip
There is water leaking from the coupling between the handpiece and the cable	The waterproof O-ring is damaged	Change the new waterproof O-ring
The U-file does not vibrate	The screw is loose	Tighten it
	Endochuck is damaged	Change the new endochuck
There is noise coming from the endochuck	The screw is loose	Tighten it



**Notice:**

If the problem still cannot be solved, please contact with local dealer or manufacturer.



[note 1]

Turn the water control knob as symbol shown. It comes to the min, on the contrary direction, it comes to the max.

[note 2]

- 1) Clean the water pipe with the multi-function syringe of the dental unit;
- 2) Disconnect the water pipe from main unit;
- 3) Get through to the power and turn on the power switch;
- 4) Connect the multi-function syringe of dental unit to the water pipe;
- 5) Disassemble the tip or handpiece;
- 6) Step on the foot switch;
- 7) Turn on the switch of the multi-function syringe, press the water into the machine and the impurity blocked in the water pipe can be eliminated.

[note 3]

If the scaling tip has been screwed on tightly and there is fine spray too, the following phenomena show that the scaling tip is damaged:

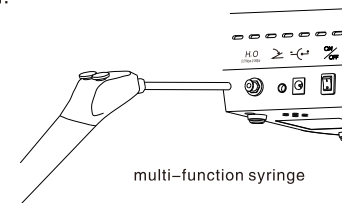

### TROUBLESHOOTING FOR THE ELECTROMAGNETIC VALVE

If the water is not clean or the electromagnetic valve works too long, there will be the scale and impurity generated on the inside wall and valve plug. It will Cause the water way to be blocked, and could repair as following steps:

- 1) Follow the [note2]
- 2) Uninstall the electromagnetic valve by following steps:
  - a) Turn off the power, and unplug the power cable;
  - b) Unscrew the cap, and move out the hood of main unit;
  - c) Unscrew the cap on the electricmagnetic valve, and Uninstall h electromagnetic valve as shown on Figure;
  - d) Take out the valve plug. and clean out the impurity on the inside wall;
  - e) Install The parts as shown on the figure.
  - f) Ensure the water way is working by repeat [note 2].

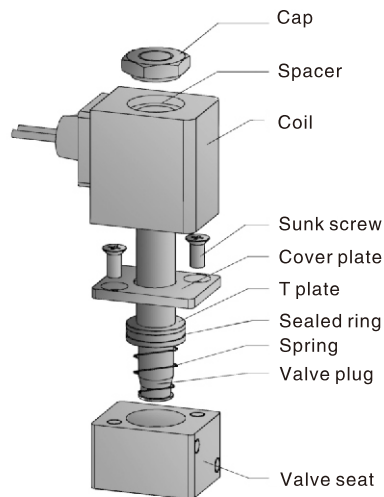

### EMC DECLARARION

Guidance and manufacturer' s declaration--electromagnetic emissions		
The models K08A/K08AL Dental Ultrasonic SandBlasting Scaler are intended for use in the electromagnetic environment specified below. The customer or the user of the K08A/K08AL Dental Ultrasonic SandBlasting Scaler should assure that it is used in such an environment.		
Emissions test	Compliance	Electromagnetic emissions--guidance
Radiated Emission EN 60601-1-2:2015 EN55011:2016+A1:2017	Class B	The models K08A/K08AL Dental Ultrasonic Sandblasting Scaler use RF energy only for its internal function. Therefore, its RF emissions are very low and are not likely to cause any interference in nearby electronic equipment.
Conducted Emissions EN 60601-1-2:2015 EN55011:2016+A1:2017	Class B	The models K08A/K08AL Ultrasonic Periodontal Therapy System are suitable for used in domestic establishment directly connected to a low voltage power supply network which supplies buildings used for domestic purposes.
Harmonic Current EN 60601-1-2:2015 EN 61000-3-2:2014	Test configuration and procedure see clause 7.1 of standard EN 61000-3-2:2014	
Voltage Fluctuations/ Flicker Emissions EN 60601-1-2:2015 EN 61000-3-3:2014	Test configuration and procedure see clause 5 of standard EN 61000-3-3:2013	

Guidance and Manufacturer' s Declaration--Electromagnetci Immunity

Guidance and Manufacturer' s Declaration--Electromagnetci Immunity		
The models VR-K08A Ultrasonic Periodontal Therapy System are intended for use in the electromagnetic environment specified below. The customer or the user of the VRN-K08A Ultrasonic Periodontal Therapy System should assure that it is used in such an environment.		
Immunity Test	Compliance	Electromagnetic emissions--guidance
Electrostatic Discharge EN60601-1-2:2015 EN61000-4-2:2009	± 15KV for air discharge ± 8KV contact discharge	Floors should be wood, concrete or ceramic tile. If floors are covers with synthetic material, the relative humidity should be at least 30%.
Electrical Fast Transient/Burst	± 2KV a.c power lines	Main power quality should be that of a typical commercial or hospital environment.
Surge Test EN60601-1-2:2015 EN61000-4-5:2014	± 1KV a.c power line(s) to line(s)	Main power quality should be that of a typical commercial or hospital environment.

Immunity Test	Compliance	Electromagnetic emissions--guidance
Conducted Disturbance Snducedby Radio-frequeng Fields	comply with the requirments if clanse 8.9 of EN60601-1-1-2:2015 at immunity test levels of 3Vrms and 6Vrms over the frequency range beginning at the start frequency and extending to 80MHZ	For AC power input lines: EUT is placed on an insulating support of 0.1m high above a ground re-erence plane. It must be 0.3m away the CDN (coupling and decoupling network)of which the bottom is made of metallic mtaerial and placed above the groundreference plane shall be between 30 and 50mm(where possible).The disturbance signal amplified by amplifieris injected to EUT through CDN. For Signal Line and Control Line: EUT is placed on an insulating support above a groundreference plane .The EM camp is directly placed on the ground reference plane with its me- tallic bottom contacting the plane. Gables betw- een EUT and auxiliary equipment are put through the EM clamp.The disturbance signal amplified by amplifier is injected to EUT through EM clamp. Record any performance degradation of the EUT during the testand judge the test result according to performance criterion.
Voltage Dips and Interruptionsg	100%/10ms,20ms 30%/500ms	EUT is connected to the simulator according to thetest photo. When conducting this, the power supply shall be set at the minimum and maximum rated input voltages and test voltage changes shall be step changes at the phaseangle of 0° , 45° ,90° ,135° ,180° ,225,270° and315°

Immunity Test	Compliance	Electromagnetic emissions–guidance
Radiated, Radio–frequency, electromagnetic field	comply with the requirements of clause 8.9 of EN60601–1–2:2015 at immunity test levels	EUT and its auxiliary instrument are placed on a turntable which is 0.8 meter above ground. Transmitting antenna mounted on an antenna mast is set 3 meter away from the EUT. During the test, each of the four sides of EUT will face the transmitting antenna with the turntable cycled. Both horizontal and vertical polarization of the antenna are set on testand measured individually IN order to judge the performance of the EUT, a set of monitor system is used. Record any performance degradation of the EUT during the test and judge the test result according to performance criterion.